

Yacht Devices

User Manual

NMEA 2000 Wi-Fi Router YDNR-02N

Firmware version

1.00

2019

Package Contents

Device	1 pc.
Wi-Fi antenna	1 pc.
Screws	2 pcs.
This Manual	1 pc.
Paperclip for reset	1 pc.
NMEA 2000 Drop Cable	not supplied

© 2019 Yacht Devices Ltd. Document YDNR02-001, April 6, 2019. Web: <http://www.yachtd.com/>

NMEA 2000® is a registered trademark of the National Marine Electronics Association. SeaTalk NG is a registered trademark of Raymarine UK Limited. Garmin® is a registered trademark of Garmin Ltd.

Contents

Introduction	4
Warranty and Technical Support	6
I. Product Specification	7
II. Installation of Device and Connection to NMEA 2000 Network	9
III. Wi-Fi Settings	12
IV. Connecting with NMEA 0183 and SeaTalk Equipment	16
V. Configuration of Application Protocols	19
VI. NMEA Routing and Tunnel Settings	23
VII. Message Filters	26
VIII. LED Signals	31
IX. Reset of Settings and Hardware Reset	33
X. Recording of Diagnostics Data	34
XI. Firmware Updates	36
XII. NMEA Settings and Autopilot Control	38
XIII. Web Gauges of Administrative Web Site	43
APPENDIX A. Troubleshooting	45
APPENDIX B. NMEA 2000 Messages Supported by Device	47
APPENDIX C. Conversions Between NMEA 2000 and NMEA 0183	48
APPENDIX D. Conversions Between SeaTalk and NMEA 0183	55
APPENDIX E. Format of Messages in RAW Mode	57

Introduction

The NMEA 2000 Wi-Fi Router (hereinafter Router or Device) is a multifunctional marine data converter, multiplexer and gateway which allows a user to:

- see data from marine digital networks on a laptop or smartphone;
- connect old NMEA 0183 and SeaTalk equipment to modern chart plotters;
- connect marine devices using different protocols or port speed;
- configure and update NMEA 2000 devices, record and diagnose marine equipment using a free software supplied with the device;
- implement a wireless extender and bridge between SeaTalk, NMEA 0183 and NMEA 2000 devices (two Routers required).

The Router creates its own Wi-Fi network (with range of about 30 meters in open spaces) or it can be connected to an existing Wi-Fi network. The built-in web server allows easy configuration of the Router from any Wi-Fi enabled device (laptop or smartphone) with a web browser.

The Web Gauges page of the built-in web site allows managing of digital switching equipment and real time viewing of vessel data using a web browser on PC, laptop, tablet or smartphone; no internet connection or app installation is required. If you have access to your boat Wi-Fi network over the internet, Web Gauges are a ready solution to monitor and manage your vessel.

The Router's data servers supports TCP and UDP network protocols (both can be enabled at the same time) as well as NMEA 0183 and NMEA 2000 (RAW) data protocols. For UDP protocol, the number of clients (physical devices or software applications) is unlimited.

The Device has a bi-directional converter between NMEA 2000, NMEA 0183 and SeaTalk protocols. Therefore the Router is compatible with virtually all marine software except applications especially designed for use only with specific hardware. A powerful system of data filters allows configuration of output data for feature-limited mobile applications.

The free CAN Log Viewer software (available at www.yachtd.com) works under Microsoft Windows, Linux and Mac OS X. It allows viewing NMEA 2000 and J1939 messages and data in real time, configuring

NMEA 2000 devices and updating firmware of products of our company.

We hope that you will like this tiny, low-power, but powerful device. Thank you for purchasing our product and happy voyages!

Warranty and Technical Support

1. The Device warranty is valid for two years from the date of purchase. If a Device was purchased in a retail store, the sales receipt may be requested when applying for a warranty claim.
2. The Device warranty is terminated in case of violation of the instructions in this Manual, case integrity breach, or repair or modification of the Device without the manufacturer's written permission.
3. If a warranty request is accepted, the defective Device must be sent to the manufacturer.
4. The warranty liabilities include repair and/or replacement of the goods and do not include the cost of equipment installation or configuration, neither shipping of the defective Device to the manufacturer.
5. Responsibility of the manufacturer in case of any damage as a consequence of the Device's operation or installation is limited to the Device cost.
6. The manufacturer is not responsible for any errors and inaccuracies in guides and instructions of other companies.
7. The Device requires no maintenance. The Device's case is non-dismountable.
8. In the event of a failure, please refer to Appendix A before contacting technical support.
9. The manufacturer accepts applications under warranty and provides technical support only via e-mail or from authorized dealers.
10. The contact details of the manufacturer and a list of the authorized dealers are published on the website: <http://www.yachtd.com/>.

I. Product Specification

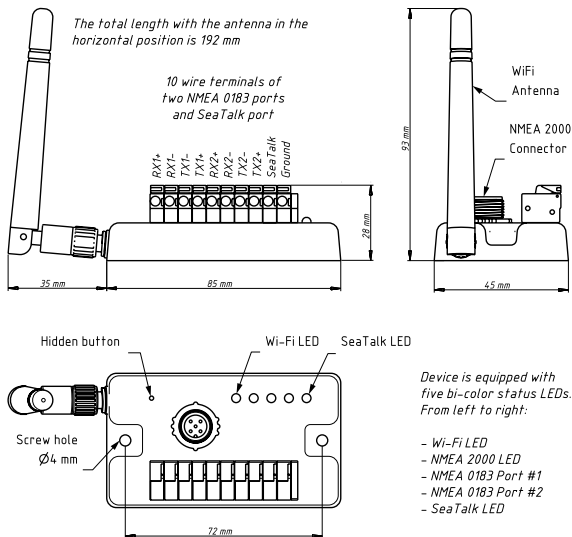

Figure 1. Drawing of NMEA 2000 Wi-Fi Router YDNR-02

Device parameter	Value	Unit
Supply voltage (from NMEA 2000 network)	7..17	V
Max. current consumption, all NMEA 0183 ports with 100 Ohm load	60	mA
Load equivalency number	2	LEN
Number of NMEA 0183 TX/ NMEA 0183 RX / SeaTalk ports	2 / 2 / 1	—
NMEA 0183 receiver input resistance	12	kOhm
Wi-Fi module 2.4 GHz	802.11b/g/n	—
Wi-Fi signal range (open space)	30 / 100	m / feet
Wi-Fi connections in Access Point mode (max.)	3	—
TCP connections from applications (max.)	9	—
UDP clients (applications or devices)	Unlimited	—
Device case without antenna (LxWxH)	85x45x28	mm
Total height/length with the antenna in vertical/horizontal position	93 / 192	mm
Weight	80	g
Operating temperature range	-20..55	°C



Yacht Devices Ltd declares that this product is compliant with the essential requirements of EMC directive 2014/30/EU and radio and TTE directive 1999/5/EC.



Dispose of this product in accordance with the WEEE Directive. Do not mix electronic waste with domestic or industrial refuse.

II. Installation of Device and Connection to NMEA 2000 Network

The Device requires no maintenance. When deciding where to install the Device, choose a dry mounting location. Despite the fact that the Router case is waterproof, the terminals are open and seawater can cause a short circuit. Do not place the device where it can be flooded by water, get wet in the rain or be sprayed with water.

Note that conductive materials (metals) weaken the Wi-Fi signal or may even completely block it. Do not place the Device behind a metal bulkhead. Metals reflect radio signals, and you should avoid (if possible) placing the Device in front of metal bulkheads also. Plastic or wood (and many other non-conductive materials) did not significantly affect the signal.

The Device is well-suited for fiberglass and plastic sailing yachts as well as motor boats up to 65 feet (20 m) in length. With good signal strength over a 30m area in open space, the Device provides good coverage inside and outside the boat.

On metal vessels or large vessels, an external Wi-Fi router may be required. In this case, coverage depends on the coverage of the base network, which can contain multiple Wi-Fi routers connected by Ethernet (for example).

The Router can be fixed horizontally or vertically using the two screw holes (4 mm diameter, 72 mm between centers) and screws supplied. When the holes of wire terminals are pointing down, they are better protected from occasional water spray.

The Device is powered from an NMEA 2000 network and should be connected to the NMEA 2000 network backbone with a NMEA 2000 drop cable (not supplied with the Device). For networks with proprietary connectors (Raymarine SeaTalk NG, Smirad SimNet), a cable adapter is required:

- for SeaTalk NG, cable with Raymarine part numbers A06045 or A06075;
- for SimNet, cable with Navico part number 24006199.

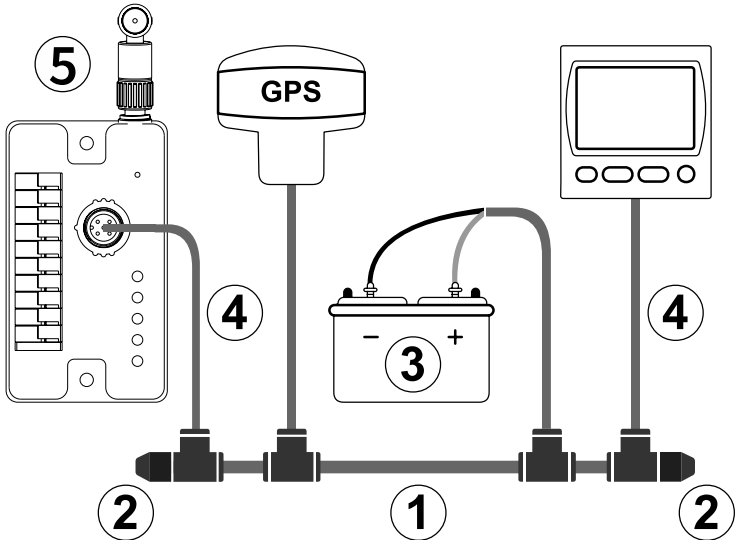

Figure 1. Basic NMEA 2000 network (1- backbone, 2 – terminators, 3 – dedicated 12V power, 4 – drop cable; 5 - Router)

If you have no NMEA 2000 network installed, please note that you cannot simply connect the Router to the NMEA 2000 port of your chart plotter, you should install the NMEA 2000 network first (see Figure 1). Please refer to this article for details:

<https://www.yachtd.com/faq/#n2k>

Before connecting the Device to NMEA 2000, turn off the bus power supply. Refer to the following documents if you have any questions regarding the use of connecting cables, terminators or connectors:

- SeaTalk NG Reference Manual (81300-1) for Raymarine networks
- Technical Reference for Garmin NMEA 2000 Products (190-00891-00) for Garmin networks

After turning on the NMEA 2000 network power supply, all five LEDs of the Router will light up in green once, indicating that the Router is powered and functioning, and then start flashing (see Section VIII for details).

You can also check the NMEA 2000 connection and firmware version from a chart plotter. Please, see Section XI for details.

III. Wi-Fi Settings

The Device can work in Access Point mode (factory defaults) and in Client mode, when the Device is connected to an existing Wi-Fi network. To configure the Router, you need any Wi-Fi enabled device (laptop or smartphone) with a web browser.

1. Access Point mode

In the Access Point mode, the Device creates its own Wi-Fi network with the name «YDNR» (SSID) and password 12345678. To open the administrative web site, connect to this network and type <http://192.168.4.1> in a web browser. Use the login «admin» and password «admin» (without quotes) to log into the administrative web site.

The administrative web site has a navigation menu on the left; in the mobile version, the menu is accessible by clicking on the icon in the top left corner.

On the «Wi-Fi Access Point» page, you can change the Wi-Fi network name (SSID), password, change the authentication type and make the network hidden. Hidden networks are not visible in the list of Wi-Fi networks, and you can connect to such networks only by entering its name. To enter the name, click on the option with a name like «Other network...» in the list of Wi-Fi networks.



We strongly recommend changing the default Wi-Fi password. A hijacker can take control of autopilot and other important ship systems. In the air drone era, this can happen even far from shore.

Up to three Wi-Fi connections are supported in Access Point mode. You can switch the Device to Client mode to avoid this limitation.

2. Client mode

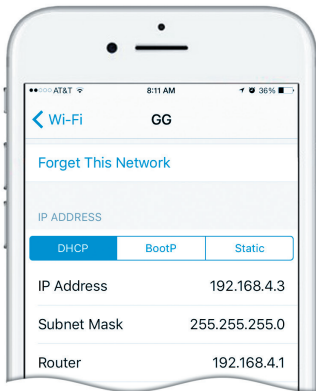

Figure 1. Wi-Fi details on iPhone 6

In this mode, the Router connects to an existing Wi-Fi network. To switch to this mode from Access Point mode, or to tune the settings, open the «Wi-Fi Client» page on the administrative web site.

The Router must have a fixed IP address. This can be done in the wireless access point (network router) settings; you can assign a fixed IP address by the MAC address of the Router printed on the «Wi-Fi Client» page. In this case, you can leave the default «Use DHCP» setting in the IP address configuration. Note

that the Router has two different MAC addresses, one for the internal Access Point and one for connecting to other networks. You should use the MAC address from the «Wi-Fi Client» page.

Or you can choose «Static IP» address and enter an IP, subnet mask and network router address. In most cases, you can open the settings of the Wi-Fi network on a smartphone or PC, and copy the mask address and network router address and select a free IP address from this subnet. For example, if the router has the address 192.168.4.1 (see Figure 1 on the previous page) and a smartphone has the address 192.168.4.3, you can try 192.168.4.100. This is far enough from the address assigned to smartphone.

In case of difficulty, contact your network router administrator or refer to the router documentation.

The «Save» button saves settings to EEPROM, and they will be applied at the next connection to the Wi-Fi network. The «Save & Apply» button saves settings and tries immediately to apply them if the Router is in Client mode already.

Choose the network from the list or enter the name of a hidden network in the «Other...» edit box and click «Connect».



If the Router was in Access Point mode before, it will shutdown the «YDNR» network after successful connection. Your client device (smartphone, laptop) will continue searching for a non-existing network, and you may need to change the Wi-Fi network manually and enter the new IP address of administrative web site in the browser.

For example, you connect the Router to the network «Yacht» and specify 192.168.1.100 as the address in the static IP address field. You should connect your smartphone or laptop to the «Yacht» network and type <http://192.168.1.100> in the web browser to open administrative web site.

3. What to do if the Device is not accessible

There many possible reasons why you may not be able connect to the Router after changing settings. Check the following:

- was the IP address configured before switching to Client mode?
- what is the Router state according the LED signals? (see the Section VIII)
- is your smartphone or laptop connected to the same Wi-Fi network as the Router?
- what IP address was assigned to the Router? (in wireless router settings)

If you cannot diagnose what is wrong, you can reset the Device's settings (see Section IX) and the Device will be returned to Access Point mode. You can connect to «YDNR» network again and try to change the settings one more time.

4. Other important settings

We also strongly recommend changing the default password for access to the administrative web site. This can be done on the «Administration» page.

Access to port 80 (default port of web server) can be limited in some network configurations, and you may change the port on the «Home» page to a different number, 8000 for example. In this case, you will need to type <http://192.168.4.1:8000> in the address bar of browser instead of <http://192.168.4.1> to get access to the administration web site.

IV. Connecting with NMEA 0183 and SeaTalk Equipment

Before connecting of NMEA 0183 or SeaTalk equipment, be sure that you have access to the administrative web site of the Router (see the previous Section). Wire terminals and the status LED location are shown in Figure 1 of Section I.

1. NMEA 0183 basics

The default speed of a NMEA 0183 interface is 4800 baud. High-speed interfaces are 38400 baud and were designed especially for AIS, but usually chart plotters and instrument displays allow any data (not only AIS) on a high-speed port. On a chart plotter, port speed can be configured in the settings. NMEA 0183 uses different wires for talking (transmitting, TX) and listening (receiving, RX) data.

One talker can be connected to multiple listeners, but a listener can have only one talker connected. The Device can act as a «multiplexer» and join the output of two physical talkers to a single data stream.

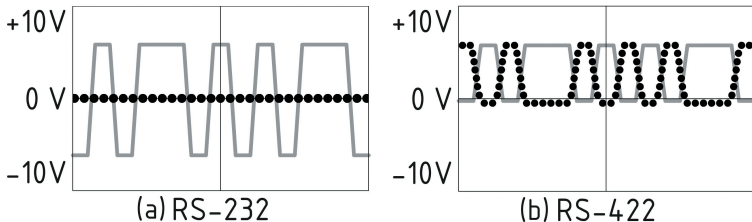

Figure 1. (a) RS-232 and (b) RS-422

NMEA 0183, until version 2.0 (1992), used a «single ended» RS-232 interface with one TX line and one RX signal line (grey at Figure 1.a) and ground line (dotted at Figure 1.a) used as reference for TX and RX

signals. Therefore, old devices have only three wires.

Since Version 2.0, NMEA 0183 has been based on a «differential» RS-422 interface, which has two RX lines RX+ (can also be marked as «A») and RX- (or «B»), two TX lines TX+ (or «A», grey at Figure 1.b) and TX- (or «B», dotted at Figure 1) and a ground (not shown at Figure 1.b). Modern devices use five wires.

Devices of different versions can be connected, but with one cautionary note. TX- («B») is not equal to a ground line. Voltage on the TX- line (dotted on Figure 1.b) changes from 0 to 5V, and connecting this line to ground line can cause a short circuit.

The correct connection schemes are shown in Figure 2.

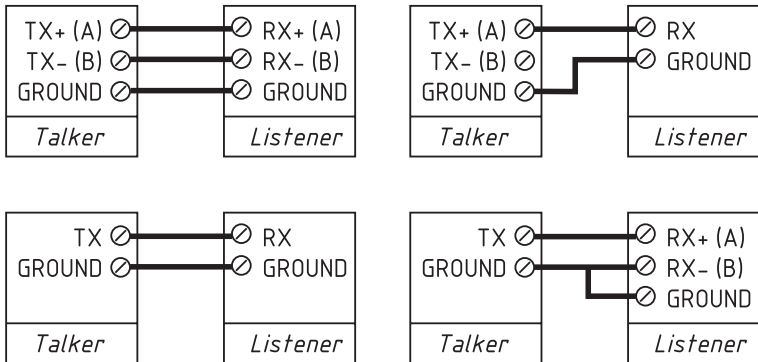

Figure 2. Connection of NMEA 0183 devices

2. Connecting to NMEA 0183 equipment

The Router has two NMEA 0183 ports (Port #1 and Port #2) with configurable speed from 300 to 115200 baud. The Router is supplied with Port #1 configured for 4800 baud and Port #2 configured for 38400 baud, port speed can be changed at «NMEA Settings» page of administrative web site.

The ground wire of NMEA 0183 equipment (if present) should be connected to Router's ground terminal (GND). This terminal is common with NMEA 2000 ground.

Each NMEA 0183 port has dedicated bi-color status LED. The state of the connection can be determined by LED signals (see the Section VIII).

3. Connecting to SeaTalk equipment

SeaTalk is a proprietary binary protocol of Raymarine company. It allows co-existence of multiple devices on the bus, so the Router has only one SeaTalk port. A bi-directional converter between SeaTalk, NMEA 0183 and NMEA 2000 supports all known SeaTalk datagrams, including autopilot (see Appendix D for details). This allows controlling SeaTalk autopilots from NMEA 0183 chart plotters and marine apps.

A SeaTalk bus has three wires: 12-Volt power supply (red label on equipment, red lead within a SeaTalk cable), ground (white or grey label on equipment, bare shield within a SeaTalk cable) and data (yellow label, yellow lead within a cable).

The data wire should be connected to the «SeaTalk» terminal of the Router, the ground wire of the SeaTalk bus should be connected to the Router's ground terminal (GND), and power supply wire is not connecting and must be isolated.

The state of the connection can be determined by SeaTalk status LED signals (see the Section VIII).

V. Configuration of Application Protocols

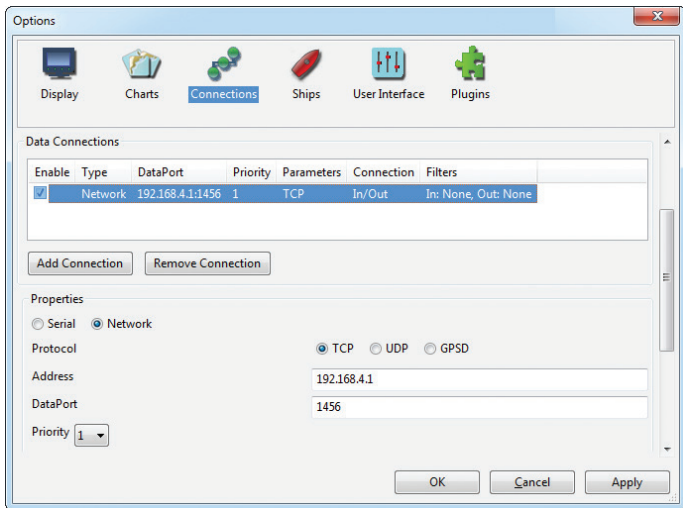

Figure 1. Settings of OpenCPN application

Most marine applications support both TCP and UDP network protocols. TCP is a connection-oriented protocol. This means that the receiver must confirm reception of data before it gets the next packet of data, otherwise the sender repeats the transmission after a timeout. So, the second TCP connection doubles the network traffic and CPU load, despite the fact that both clients receive the same data.

UDP is a connectionless protocol; any number of clients can listen to data broadcasted from a specified port without any additional load on the server and without increasing the actual network traffic. We recommend using UDP protocol where possible, because the resources of the Device's CPU are limited and UDP protocol may work 5-6 times faster than TCP.

The Router supports RAW and NMEA 0183 data protocols. The RAW protocol is supported in Expedition 10 and CAN Log Viewer. This protocol is very simple, open, and also supported by our NMEA 2000 USB Gateway YDNU-02 and other products. We hope that this protocol becomes popular among software developers.

NMEA 0183 data protocol is supported in virtually all marine applications. The Router contains a bi-directional converter between NMEA 0183, NMEA 2000 and SeaTalk, and has a flexible system of message filters (see Section VII) and messages routing (see the next Section).

On the «NMEA Server» page on the administrative web site you can set up to three server ports (see Figure 2 on the next page). If TCP network protocol is selected, up to three connections (from three different applications on one device, or from three devices with one marine application running on each) are allowed at the same time. So three servers allow nine connections in total.

In the case of using UDP protocol, the number of devices or applications used the data port is not limited. We recommend using UDP protocol when possible.

The server port can be configured as bi-direction, read-only (Transmit Only) or write-only (Receive Only). We recommend configuring data ports as read-only if possible, to prevent network flooding from incorrectly configured applications.

← → ↻ 192.168.4.1/servers.html

NMEA Data Servers

You can configure up to three servers. Up to three connections (from three different applications on one device, or from three devices with one marine application running on each) are allowed on TCP servers the same time. In the case of using UDP protocol, the number of devices or applications using the data port is not limited. We recommend using UDP protocol when possible.

Note: [Web Gauges](#) require Server #1 configured to NMEA 0183 protocol.

Server #1

Network Protocol	Data Protocol	Port	Direction
TCP	NMEA 0183	1456	Transmit Only

Server #2

Network Protocol	Data Protocol	Port	Direction
TCP	NMEA 0183	1457	Transmit Only

Server #3

Network Protocol	Data Protocol	Port	Direction
UDP	NMEA 0183	1458	Transmit Only

[Update](#)

Figure 2. Data server settings

Server 3 also supports the «Debug» data protocol, designed to diagnose hardware or software issues. This protocol is described in the Section X.

With the factory settings, Router has the 1st server enabled and pre-configured to use TCP port 1456 and the NMEA 0183 data protocol. To connect your application to the Router with factory settings:

- connect your laptop or mobile device to YDNR network;
- set the IP address 192.168.4.1 in the application settings;
- specify the TCP protocol and port 1456 in the application settings.

To use the Router with a Navionics Boating App, no settings are required in the app, but some changes are required in the Router configuration:

- configure one of the Router servers to use UDP port 2000 and NMEA 0183 data protocol;
- connect your smartphone or tablet to the Routers's Wi-Fi network.

A pair of Routers can act as a wireless extender, allowing joining of two or more physical networks or devices. To pair Routers, you need to set up both using UDP protocol and set the same port number.

The settings on the «NMEA Settings» page are designed to control an autopilot by NMEA 0183 protocol and tune NMEA 0183 output, see the Section XII for details.

VI. NMEA Routing and Tunnel Settings

On the «NMEA Routing» page of administrative website you can easily manage data flows. For NMEA 0183 physical ports, you can route them to themselves, which allows connecting the Router «in-line» between two devices and enriching the data flow by data from NMEA 2000, SeaTalk or other NMEA 0183 device (see Figure 1).

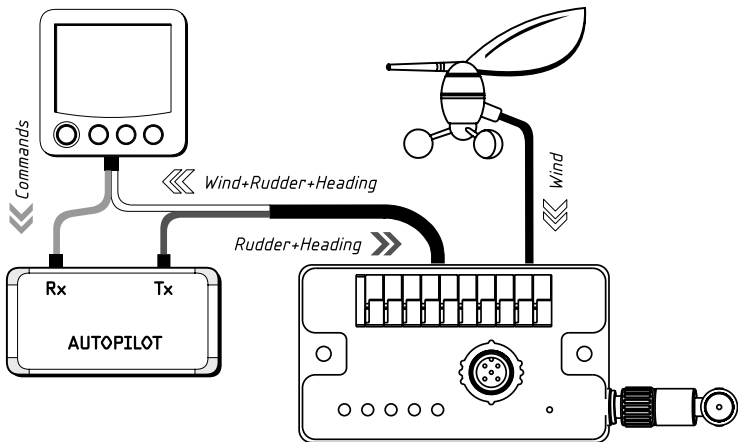

Figure 1. Routing of NMEA 0183 Port #2 to itself

← → 🔄 Not secure | 192.168.4.1/routing.html ☆ ⋮

NMEA Routing

You can select output ports and servers for each input source. Note that each server has individual filters, and a routed sentence can be filtered out by output filters of the selected server.

Tunnelling allows routing of incorrect NMEA 0183 sentences from the server or port, including sentences with an invalid checksum. Invalid sentences are not processed by incoming filters of input server/port or outgoing filters of output port/server. Correct sentences are always processed by filters, whether tunnelling is off or on.

Input		Output						
		TCP/UDP Server			N2K	Port 0183		ST
Port/Server	Tunnel	1	2	3		1	2	
Server #1	<input type="checkbox"/>	—	<input type="checkbox"/>	<input type="checkbox"/>	<input checked="" type="checkbox"/>	<input checked="" type="checkbox"/>	<input checked="" type="checkbox"/>	<input checked="" type="checkbox"/>
Server #2	<input type="checkbox"/>	<input type="checkbox"/>	—	<input type="checkbox"/>	<input checked="" type="checkbox"/>	<input checked="" type="checkbox"/>	<input checked="" type="checkbox"/>	<input checked="" type="checkbox"/>
Server #3	<input type="checkbox"/>	<input type="checkbox"/>	<input type="checkbox"/>	—	<input checked="" type="checkbox"/>	<input checked="" type="checkbox"/>	<input checked="" type="checkbox"/>	<input checked="" type="checkbox"/>
NMEA 2000	—	<input checked="" type="checkbox"/>	<input checked="" type="checkbox"/>	<input checked="" type="checkbox"/>	—	<input checked="" type="checkbox"/>	<input checked="" type="checkbox"/>	<input checked="" type="checkbox"/>
Port 0183 #1	<input type="checkbox"/>	<input checked="" type="checkbox"/>	<input checked="" type="checkbox"/>	<input checked="" type="checkbox"/>	<input checked="" type="checkbox"/>	<input type="checkbox"/>	<input type="checkbox"/>	<input checked="" type="checkbox"/>
Port 0183 #2	<input type="checkbox"/>	<input checked="" type="checkbox"/>	<input checked="" type="checkbox"/>	<input checked="" type="checkbox"/>	<input checked="" type="checkbox"/>	<input type="checkbox"/>	<input type="checkbox"/>	<input checked="" type="checkbox"/>
SeaTalk (ST)	—	<input checked="" type="checkbox"/>	<input checked="" type="checkbox"/>	<input checked="" type="checkbox"/>	<input checked="" type="checkbox"/>	<input checked="" type="checkbox"/>	<input checked="" type="checkbox"/>	—

[Check all](#) [Uncheck all](#)

Figure 2. Factory routing settings

When data are routed from NMEA 2000 or a data server configured for RAW protocol to NMEA 0183 port or to a data server configured for NMEA 0183 protocol, they are converted to NMEA 0183 (see Appendix C). When data are routed to SeaTalk port, they are converted to NMEA 0183 and then to SeaTalk from NMEA 0183 (see Appendix D).

The SeaTalk (also known as SeaTalk 1) is a binary protocol, and an intermediate NMEA 0183 layer allows seeing data in readable form (for example, at Debug server, see the Section X) and processing data using NMEA 0183 filters (see the next Section).

The same conversion rules work in the opposite direction. Routing rules have some exclusions for data server #3 when it is configured for Debug protocol, see Section X for details.

The NMEA 2000 port and each server configured for RAW protocol has its own instance of the data converter to process incoming and outgoing NMEA 0183 and SeaTalk data (see the Figure 1 in the next Section). For example, you have a heading sensor in the NMEA 2000 network and have a RAW data server, which receives data only from the wind sensor connected to NMEA 0183 port, but not from NMEA 2000. In this case, you will have only apparent wind data on the RAW data server.

To obtain true wind direction, you should turn on the routing from NMEA 2000 to this RAW data server. If you need only wind data on this RAW data server, but none of the other data from NMEA 2000, you can filter out all other messages (see the next Section).

The «Tunnel» setting (first column of checkboxes at Figure 2) acts only for NMEA 0183 ports and data servers configured for the NMEA 0183 protocol.

The Router ignores incorrect sentences received, including sentences with an invalid checksum. The «Tunnel» allows routing of incorrect sentences from this server and conversion to NMEA 2000 if required. This allows connection of Navtex and rare NMEA equipment produced decades ago when a checksum was not a mandatory part of the sentence.

VII. Message Filters

The Device has 20 filter lists which allow limiting the set of incoming and outgoing messages individually for each data server or port. To modify filters, open the «NMEA Filters» page on the administrative website.

Each of the three data servers has four filter lists: two for incoming («Receive») and outgoing («Transmit») NMEA 0183 messages, and two for incoming and outgoing NMEA 2000 messages (used for RAW protocol). What filters are used depends on the server data protocol set on the «NMEA Servers» page for this server.

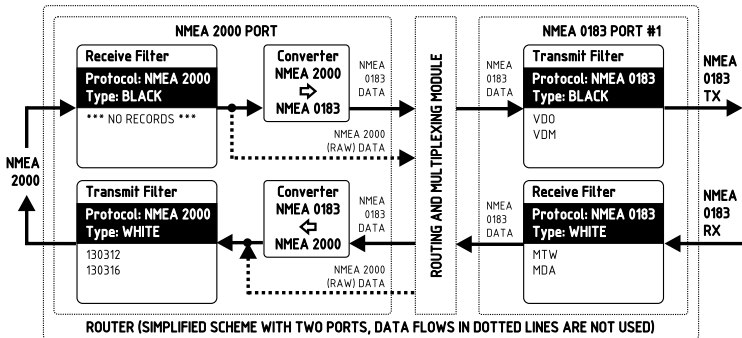

Figure 1. Simplified scheme of the Router with two ports

The NMEA 2000 port has two filters for incoming and outgoing NMEA 2000 messages. SeaTalk port and NMEA 0183 ports has two filters each for incoming and outgoing NMEA 0183 messages.

Each filter list has a switchable type: WHITE or BLACK. A message is passed through the WHITE filter

if it contains a record matched with a message. And the reverse for BLACK. In the factory settings, all filter lists are empty and are of BLACK type, so all messages are passed through the filters.

At the Figure 1 (the scheme is simplified) the Router is configured to:

- transmit all data from NMEA 2000 to NMEA 0183 Port #1 except AIS messages (VDO and VDM sentences);
- receive only environmental data from Port #1 (dew point, water and air temperatures, atmospheric pressure, relative humidity from MDA and MTW sentences), but transmit to NMEA 2000 only temperature data (PGN 130312 and 130316).

Filter syntax is described below.

1. Syntax of NMEA 0183 filters

NMEA 0183 filters contain 3-char NMEA 0183 sentence formatters separated by a space character. According to the Standard, an NMEA 0183 sentence starts with a \$ or ! symbol, followed by a two-character talker ID and a 3-char sentence formatter. These elements are followed by data fields (after the comma). The sentence is finished by a check sum after the * (asterisk) symbol.

The Router uses 3-char sentence formatters for filtering. The following sentences matches to GLL and VDM records (sentence formatters):

```
$GPGLL,4146.5894,N,07029.6952,W,173412.02,A*15
!AIVDM,1,1,,B,ENk`smq71h@@@@@@@@@@@@@@@@=MeR6<7rpP00003vf400,4*5F
```

Example of correct NMEA 0183 filter text:

```
GLL VDM DPT
```

In the «Tunnel» mode (see the previous Section) the Router processes invalid NMEA 0183 sentences received, including sentences with invalid checksum. Invalid sentences are not processed by incoming filters or outgoing filters of output server/port. Correct sentences are always processed by filters, whether tunneling is off or on.

2. SeaTalk filter features

The Router has a bi-directional converter between SeaTalk and NMEA 0183. On the Seataalk port you can use NMEA 0183 filters and datagram filters («Sxx», where xx is a hexadecimal datagram number, see Appendix D).

For example, a NMEA 0183 water temperature MTW sentence is converted to Seataalk datagrams 23 and 27 (hexadecimal). To prevent sending water temperature to or from SeaTalk, you can specify the sentence filter «MTW» (temperature will be filtered out at NMEA 0183 level) or «S23 S27» (will be filtered at datagram level).

In case of a WHITE filter on the SeaTalk port, you should specify «MTW S23 S27» to allow water temperature processing because you need to allow processing of SeaTalk datagrams 23 and 27 and generation of MTW sentence.

3. Syntax of NMEA 2000 (RAW protocol) filters

You should be familiar with the NMEA 2000 Standard (can be purchased from National Marine Electronics Association, www.nmea.org) to operate with NMEA 2000 filters.

These filters actually contain pairs of 29-bit message identifiers and a mask. The identifier is compared by processing the NMEA 2000 message identifier and the second value (mask) defines the comparison concerning which bits are significant. The identifier contains a PGN (Parameter Group Number, described in NMEA 2000 Standard) and a source device address. You can use decimal and hexadecimal numbers (which start with a 0x prefix).

To simplify defining filters, it is also allowed to set filters using PGN only. The filter string contains records separated by comma. Records contain an identifier and mask separated by space, or a PGN number.

Example of correct filter:

```
0x1FD0700 0x1FFFFFFF, 130310, 1 255, 130311
```

This filter matches with messages with PGN 130311 (0x1FD07) sent by the device with address 0, PGN 130310 (sent by any device), messages sent by a device with address 1 («1 255» is another form

of the record «0x0000001 0x0000FF»), and PGN 130311 (sent by any device).

4. Configure filters

For data servers, we recommend using filters only when filtering is not available in software applications (unfortunately, this is not rare in mobile applications).

They are also very useful for physical NMEA 0183 ports configured for low speed (4800 bps), because such ports can be flooded, for example, by AIS messages (VDO and VDM) from an equipment connected to the port with 38400 bps speed or to NMEA 2000 port.

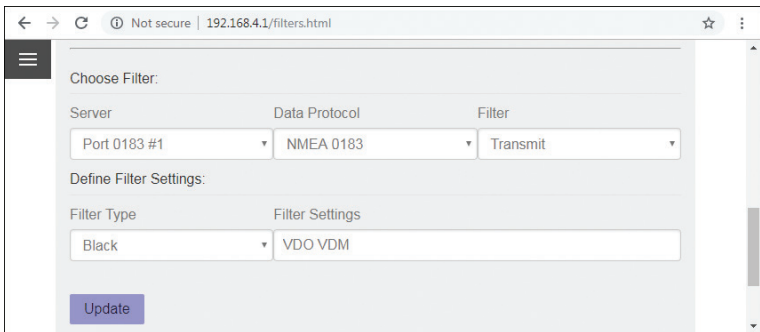

Figure 2. Blocking of outgoing AIS messages at NMEA 0183 Port #1

To configure a filter, open the «NMEA Filters» page on the administrative web site and select it with «Server», «Data Protocol» and «Filter» combo boxes. Switch the filter type to required, enter a filter string and click «Update» (to discard changes just switch to another filter). On update, the Device parses the string and returns the effective settings back. Incorrect strings are ignored by the Device.

Changes take effect immediately, and if you have diagnostics data opened in another browser window (see Section X), you can monitor the effect of changes in real time.

The button «Reset all filters» at the bottom of the page clears all filters and switches type of all filters to **BLACK**.

VIII. LED Signals

The Device is equipped with five bi-color LEDs (see Figure 1 in Section I): Wi-Fi LED and four port LEDs (NMEA 2000, NMEA 0183 Port #1, NMEA 0183 Port #2, SeaTalk). At powering on, all LEDs light up green for a few seconds from right to left in the direction starting from the Wi-Fi LED, indicating that the Device is functioning. Then LEDs start flashing in normal operation mode.

1. Signals during normal operation

During normal operation, the Device produces a series of four flashes of each LED (starting from the Wi-Fi LED) every twelve seconds. The flashes indicate the state of the Device interfaces over the last twelve seconds and have the following meaning:

- **Wi-Fi LED, flash #1:** Wi-Fi configuration. Green, if the Router is configured to use its own Wi-Fi network, Access Point mode. Red, if the Router is configured to use the boat's existing Wi-Fi network, Client mode.
- **Wi-Fi LED, flash #2:** Wi-Fi state. Red, if the Wi-Fi link is not established yet or some error has occurred (cannot connect to existing Wi-Fi network, wrong password, etc.). Otherwise green.
- **Wi-Fi LED, flash #3:** TCP connections. Green, if some clients are connected to Router services by TCP protocol. When the administrative website is browsed, the connection exists only for a short period when page is downloading from the web server. Red, if no TCP connections are open (but applications can receive data by UDP protocol at the same time).
- **Wi-Fi LED, flash #4:** data received from network. Green, if data was received by any of the network servers (by TCP or UDP protocols). Otherwise red.
- **Port LED, flash #1:** data received. Green, if any data was received by this port in the last 12 seconds.
- **Port LED, flash #2:** RX errors. Green, if any data was received and all data was received without errors. NMEA 0183 sentences contain a checksum, so any transmission error will be detected: it usually means bad electrical contact or too long wires. SeaTalk bus allows many devices (talkers) to be connected, and collisions between talkers are normal: red signal can mean high load of the bus.

For NMEA 2000, red signal means defective device on the bus or electrical problems like improper bus termination. This signal will also be red if flash #1 is red.

- **Port LED, flash #3:** data sent. Green, if data was sent to this port. NMEA 0183 and SeaTalk has no confirmation of reception, the signal does not mean that any listener received data. Red means that the Router has nothing to send.
- **Port LED, flash #4:** TX overflow. Green, if data was sent without overflow. In case of a red signal, you should increase the port speed (for NMEA 0183 ports only) or filter out unnecessary data, because the selected speed is not enough to send all the data. This signal will also be red if flash #3 is red.

With the factory settings, the Wi-Fi LED should flash GREEN-GREEN-RED-RED after the power on; this means that the Router is configured for Access Point mode, successfully created the Wi-Fi network with «YDNR» name (SSID) and has no incoming connections from mobile devices yet.

2. Signals during device reset

Hardware reset or settings reset is initiated by pressing the hidden reset button. LED signals are described in the next Section.

3. Signals during firmware update

Firmware update can be uploaded on the administrative web site. LED signals are described in the Section XI.

IX. Reset of Settings and Hardware Reset

Press the hidden reset button (see Figure 1 in Section I) with the paper clip supplied with the Router. All LEDs of the Router will constantly shine red when the hidden button is pressed.

Wait 2-3 seconds and the LEDs lights will change from red to green. Release the button to reset the Router's settings. Otherwise, LEDs will become red again 2-3 seconds later. Keep the button pressed ten seconds more, and LEDs become green. Release the button to complete a hardware reset of Device. Alternatively, wait two seconds, and LEDs returns to red.

Note that nothing happens if you release the button when the LEDs signal is red. The settings reset occurs if you release the button during the first green light period, and the hardware reset occurs in the second period.

During settings reset, the Router changes all settings to factory values (returns to Access Point Mode, network SSID to «YDNR»), and the Router will produce fast green flashes of Wi-Fi status LED for 2-3 seconds, then reboot.

During hardware reset, the Router returns to the firmware version programmed at the factory (the Router always keeps a copy of this version in EEPROM) and to the factory settings. LEDs signals during firmware updates are described in chapter XI.

Hardware reset is normally not required. It can be used for firmware rollback after installation of test firmware version.

X. Recording of Diagnostics Data

Data server #3 can be configured to «Debug» protocol, which allows investigating software or hardware issues using a web browser or using a terminal application.

In this case, all ports and servers that have routing to data server #3 enabled will send all outgoing traffic to it. All ports and servers, which have routing from server #3 enabled, will send all incoming traffic to it (it is the exclusion from general routing rules for Debug server only).

Incoming SeaTalk traffic will be present in logs in the form of converted NMEA 0183 messages. To see an incoming traffic at datagram level, turn on generation of \$STALK sentence at «NMEA Settings» page (see the Section XII.4).

Outgoing SeaTalk traffic will be presented in both forms, as NMEA 0183 messages and as SeaTalk datagrams (encapsulated to \$STALK sentence) despite settings at «NMEA Settings» page.

Web socket (used by Web Gauges) receives the same data, as software connected to server #1. That is why only incoming traffic from the web socket is displayed, to check outgoing traffic, see data sent to data server #1.

To record diagnostics data:

1. Configure server #3 to the «Debug» data protocol (it is TCP protocol).
2. Turn on the routing from the problem port or data server to server #3, to record all data sent from this port to connected device or an application.
3. Turn on the routing from server #3 to problem port or data server to record all data received by it.
4. If the problem is related to data conversion, turn on the routing from source port or data server to server #3 too.
5. If the Router has the address 192.168.4.1 and server #3 port has a number 1458, type <http://192.168.4.1:1458> in browser address bar (experienced users can also use terminal applications to get data from this port).

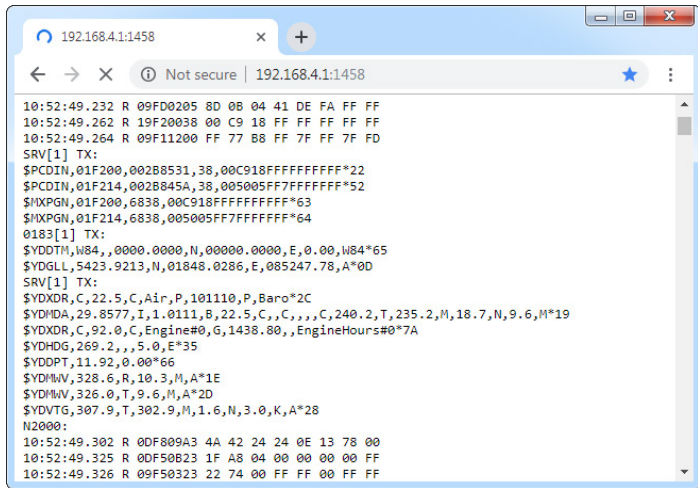

Figure 1. Chrome browser with log

Press the «Stop» button in the browser (or the Esc button in some browsers) when enough data is downloaded and save the log to the disk. Some mobile browsers do not allow saving of files, and we recommend using a laptop or PC to record diagnostics data. Some web browsers may try to download the web page again while saving. In this case, you can use the clipboard (Copy All and Paste commands of operating system) and text editor to save the data to a file.

XI. Firmware Updates

You can check the current firmware version at login or on the home page of administrative web site (see the Section III) or in the Device information section in the list of NMEA 2000 (SeaTalk NG, SimNet, Furuno CAN) devices or in the common list of external devices on the chart plotter (see the third line in Figure 1).

Usually access to this list is located in the «Diagnostics», «External Interfaces» or «External devices» menu of a chart plotter.

We recommend updating the firmware from a laptop or PC. You can download the latest firmware version from our web site: <http://www.yachttd.com/downloads/>

You should open the downloaded .ZIP archive with an update and copy the PUPDATE.BIN file to the disk. The README.TXT file inside the archive can contain important information regarding the update.

1. Log in to the administrative web site.
2. Open the «Firmware Update» page.
3. Click the «Choose File» button and locate the PUPDATE.BIN file.
4. Click the «Update the firmware» button.

The Firmware upload takes 20 – 40 seconds. After this period, you'll get a message that the update is started. The Wi-Fi status LED will be lit green for 40 – 60 seconds, then the Router will be rebooted when the update procedure is finished.

The firmware update cannot damage the Router and all settings will remain intact (unless otherwise stated in the README.TXT file provided with the update). For example, if the update procedure is interrupted due to power failure, it will be re-started at the next power on.

You can roll back all firmware updates and return to the factory firmware with hardware reset (see the Section IX).

Raymarine

Diagnostics

Select Device

Press to show diagnostic data for all devices: Show All Data

Device	Serial No	Network	Software
Digital Radome	E92129 0240451	SeaTalkHS	1.04
Raymarine p70 Display	0140299	STng	2.12
YDNR-02	00650062	STng	1.0 06/04/2019
i50 Tridata Instrument	0130213	STng	1.06
E22158-SeaTalk-STNG-Converter	1034742	STng	1.21
YDBC-05	00005027	STng	1.2 27/02/2015
Raymarine EV-1 Course Computer	0240651	STng	1.01 (RSCP V1 L4)

Standby Radar Tx Sonar GPS Fix

Figure 1. Raymarine c125 MFD devices list with the Device (YDNR-02)

XII. NMEA Settings and Autopilot Control

This chapter describes how to control NMEA 2000 (SeaTalk NG) autopilot from the application using NMEA 0183 protocol and the settings available on the «NMEA Settings» page (please, open it before reading) of the administrative web site.

1. NMEA 0183 ports speed

In this section, you can set the speed of physical NMEA 0183 Port #1 and Port #2. These settings allow choosing a speed in the range from 300 to 115200 bps, but standard NMEA 0183 equipment uses 4800 bps speed and high-speed equipment (like AIS receivers) uses 38400 bps speed. Please, see the Section IV for details.

2. True wind calculation

The wind sensor always measures apparent wind; true wind angle (TWA) is calculated using SOG or STW data and true wind direction (TWD) requires COG or heading. A chart plotter can join all these data and send calculated values to NMEA 2000, but usually TWD, TWA and TWS are not available.

Historically, STW/HDG are used to calculate true wind. However, this is not correct in places with strong current, and the «true» value of true wind can be obtained using the SOG/HDG pair. Therefore, the Router offers four options: SOG/HDG (if you love truth), SOG/COG (if you have GPS only), STW/HDG (if tradition is most important), or you can disable calculations. In the last case the Router reports true wind data only if they are calculated by another device available on the network.

The default setting «Any» means that the Router will detect what data are available on the network and will calculate true wind data using the best possible option.

3. Talker ID

You can configure the talker ID (two next characters after \$ or ! sign) for NMEA 0183 sentences generated by the Router. The default setting for the talker ID is «YD» and Router's sentences look like this:

```
$YDWPL,5441.1350,N,02014.8640,E,005*7A
```

```
$YDRTE,1,1,c,My Funny Route,001,002,003,004,005*07
```

4. SeaTalk settings

The Router has a bi-directional converter between SeaTalk and NMEA 0183 (when data from SeaTalk port are routed to NMEA 2000 or data server configured to RAW protocol, they are initially converted to NMEA 0183 and then to NMEA 2000; the same for the opposite direction).

Here you can turn on the generation of \$STALK sentences with raw SeaTalk data. This can be used for debug and diagnostics purposes, and to setup the wireless SeaTalk bridge between two physical SeaTalk networks (two Routers are required).

With the factory settings, the Router does not send datagrams to SeaTalk if they are already present on the bus (except autopilot control and waypoint transfer datagrams). In this section, you can change this behavior.

5. Autopilot control

Modern autopilots have the following modes:

- **Standby.** In this mode, autopilot is not engaged to the vessel control.
- **Auto.** The autopilot has a fixed course to steer.
- **Wind.** The autopilot steers the boat at a specified angle to the wind.
- **Waypoint.** The autopilot steers the boat to the specified waypoint.
- **Route or Track.** The autopilot steer the boat by a specified route.

The difference in the last two modes is that autopilot not only maintains the right direction to the waypoint, but also tries to follow the line from the previous to the next waypoint.

Note that the data server of the Router must be configured to work in both directions (it is configured as «Transmit Only» in factory settings) to allow control of autopilot from the application. When

NMEA 2000 autopilot is controlled from an NMEA 0183 application, it must receive:

- position of the destination waypoint (from RMB sentence);
- course from the position to the destination waypoint (APB and/or RMB);
- cross track error, means the distance and direction from the current position to the route (APB and/or RMB and/or XTE).

Depending on the implementation, the NMEA 2000 autopilot can also use the following data (and not only):

- vessel heading (HDG sentence), but in most systems the heading sensor is connected directly to the autopilot;
- rate of turn (ROT sentence);
- position, course and speed over ground (RMC sentence).

To control the autopilot, the Router should receive APB and RMB sentences from the application. The Router also needs to have magnetic variation data, which can be obtained from HDG or RMC sentences or from the NMEA 2000 messages (must be turned on in the Router settings).

If your NMEA 2000 network has GPS data, it can use data already available on NMEA 2000, meaning that sending of the ROT, HDG and RMC sentences from the application may not be required. It is better to send minimal data from a PC to the NMEA 2000 network if possible.

Depending on the autopilot sensitivity settings, autopilot can control your vessel smoothly or aggressively. The application only provides the situation (where is the waypoint and how far we are from the route), but the course to steer and the rudder angle are defined by the autopilot logic.

Switching waypoints is the work of the application. If the arrival radius is set to 1 NM, the application can switch to the next waypoint when the current point is still a mile away. If your route is circular or approximately so, the application can unexpectedly switch from the first point to the last. You should be familiar with your application settings and test how the system works on the open water.

The autopilot can warn you or ask for your confirmation when the application changes the waypoint.

It depends on autopilot settings. When the application terminates the navigation, it usually stops sending APB and RMB sentences. Autopilot usually switches to Auto mode and signals about that.

Raymarine autopilots use proprietary messages for control. The Router was tested with the two systems, but we also expect that it will work well with all other Raymarine SeaTalk NG autopilots:

- Raymarine C90W chartplotter, Raymarine SPX SmartPilot SPX30 and Raymarine ST70 Pilot Head;
- Raymarine c125 chartplotter (LightHouse 17), Raymarine EV-1 Course Computer and Raymarine ACU200 Actuator Unit.

To control Raymarine autopilot:

- Router server port must be configured to use the NMEA 0183 data protocol and to send the data in both directions (by default it is configured to «Transmit Only»);
- Raymarine autopilot support must be turned on in the settings on this page (1st setting in this section), because it is turned off by default;
- autopilot must be initially set to the Auto mode to be controlled from the application;
- the application must provide APB, RMB and RMC sentences;
- the application should provide an HDG or RMC sentences or use of 3rd setting

When the route or waypoint is activating in the application, autopilot switches to the Track mode from Auto mode. If automatic confirmations are off (default settings, 2nd setting in this section), the chart plotter and pilot head will ask for the confirmation when the waypoint is changing. When the application terminates the navigation, autopilot returns to the Auto mode.

It is impossible to switch from Track mode to Auto when the application controls the autopilot, because it will return it to the Track mode after a 5-second delay. To take control in an emergency, switch the autopilot to Standby mode.

6. XDR Settings

The XDR sentence is used to transfer data from sensors, tanks, engines, etc. This sentence contains the sensor's text identifier (name), which was not defined by NMEA Standard until the end of 2018. This lateness led to the invention of names by every company on the market. For example, B&G uses «AIRTEMP» to send air temperature data, OpenCPN software uses «TempAir», Maretron uses «ENV_OUTSIDE_T», and the NMEA 0183 Standard 4.11 defines «Air».

With these settings you can define names used in XDR to provide compatibility with software or hardware. The length of the name is limited to 16 characters.

An empty name means that data will not be sent in XDR sentence.

XIII. Web Gauges of Administrative Web Site

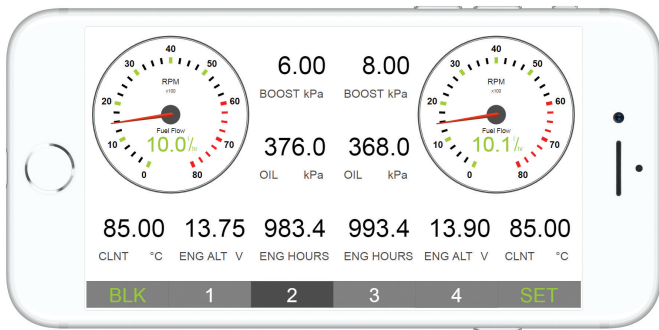

Figure 1. Built-in web gauges (Apple iPhone 8)

The Web Gauges page (WG) allow real time viewing of vessel data using a web browser on PC, laptop, tablet or smartphone and can replace instrument displays. You can open the WG using the link on the logon page of the Router's administrative web site (no authorization is required) or, if you are logged in, using the «Web Gauges» menu item. No internet connection or app installation is required.

WG offers four customizable data pages. On mobile devices you can slide pages, or you can use the numeric buttons on the menu (at the bottom of the screen) to choose the active page. Data pages are pre-configured. The first page contains circular gauges for course/speed and AWA/AWS (apparent wind angle and speed), and text data bars with STW, heading, TWS and TWA data. The second page (see Figure 1) is configured to view twin engines' data and contains circular tachometers and text data bars with engine temperature, fuel rate and other data. The third page contains data bars with position, time, log, sea and air temperature,

barometric pressure and depth surface graph with current depth value. The fourth page is not configured and contains no gauges or data bars. You can change any page's layout and its sets of data bars.

On an iPhone, iPad and Android devices, the address bar and/or menu bar of a web browser can reduce the visible area and overlap the WG menu in horizontal or vertical screen orientation. In this case, add WG to the Home Screen (see browser menu) and open it using the WG icon on the Home Screen. The page will then open in full screen mode without browser menus or address bars.

The actual WG guide is available on administrative web site (the next link after Web Gauges link at the logon page or in the menu of administrative web site) and online at:

http://www.yachtd.com/products/web_gauges.html.

APPENDIX A. Troubleshooting

Situation	Possible cause and correction
LEDs do not signal when NMEA 2000 is turned on	<p>1. No power supply on the bus. Check if the bus power is supplied (NMEA 2000 network requires a separate power connection and cannot be powered by a plotter or another Device connected to the network).</p> <p>2. Loose connection in the power supply circuit. Treat the NMEA 2000 connector with a spray for cleaning electrical contacts. Plug the Router into another connector.</p>
Cannot login to Wi-Fi network or administrative web site	<p>Wrong password or authorization settings. Reset Router's settings (see the Section IX).</p>
Cannot connect Wi-Fi device to the Router	<p>Exceeded the number of allowed connections (3) in Access Point mode. Reboot the Router to drop all Wi-Fi connections. Switch the Router to «Client Mode» (see the Section III) and connect it to chart plotter's Wi-Fi network or boat's Wi-Fi network to avoid the limitation.</p>
Cannot open TCP server port of Router in application	<p>1. Exceeded the number of TCP connections (3) to server. Configure application to use another server port or UDP protocol.</p> <p>2. IP address of Router changed. Static IP address is not configured. Get sure that you can open the administrative web site with web browser, reset Router settings in case of failure.</p>
Overflow on physical NMEA 0183 Port (4th flash is red)	<p>Too much data routed to the port. Turn off routing from unnecessary data sources (see the Section VI). If connected equipment does not need AIS data, filter out VDO and VDM sentences (see Section VII.4). Increase the port speed if connected equipment allows it (see Section XII.1).</p>

Situation	Possible cause and correction
Cannot receive data from connected NMEA 0183 equipment	<p>1. Check the physical connection, see connection schemes at Section IV.1.</p> <p>2. Check the port speed, it should be the same on both devices, see the Section XII.1.</p> <p>3. Turn on the tunnel mode for equipment manufactured before 2000, see the Section VI.</p>
Cannot receive data from connected Navtex equipment	<p>1. Check the port speed, it should be 9600 bps, see the Section XII.1</p> <p>2. Turn on the tunnel mode, because Navtex uses its own protocol, see the Section VI.</p>
Software application does not work as expected	<p>1. Check routing and filters. See Sections VI and VII.</p> <p>2. Check diagnostics data (see the Section X) and send it with a software screenshot to technical support.</p>

APPENDIX B. NMEA 2000 Messages Supported by Device

The Router can pass any message from NMEA 2000 to a PC application or in the opposite direction. «No» in the table below means that the Router will not process these messages during service communication with other devices on the network. Note that service communications are not affected by the filter settings of the Router (see the Section VII).

Appendix C contains the list of messages processed during conversion from NMEA 2000 to NMEA 0183 and from NMEA 0183 to NMEA 2000.

Table 1. Messages supported by Device

Message	Receive	Transmit
ISO Acknowledgment, PGN 59392 (0xE800)	Yes	Yes
ISO Address Claim, PGN 60928 (0xEE00)	Yes	Yes
ISO Request, PGN 59904 (0xEA00)	Yes	No
GNSS Position Data, PGN 129029 (0x1F805)	Yes	No
Local Time Offset, PGN 129033 (0x1F809)	Yes	No
PGN List Group Function, PGN 126464 (0x1EE00)	No	Yes
Product Information, PGN 126996 (0x1F014)	Yes	Yes
System Time, PGN 126992 (0x1F010)	Yes	No

APPENDIX C. Conversions Between NMEA 2000 and NMEA 0183

Table 1. Conversions from NMEA 2000 to NMEA 0183

NMEA 2000 PGN	NMEA 0183 Sentence	Comment
65311 Magnetic Variation (Raymarine Proprietary)	—	See note (4)
126992 System Time	ZDA, GLL	See also PGN 129033
127233 Man Overboard Notification (MOB)	MOB	
127237 Heading/Track Control	APB, HSC	Use PGN 129284, 129283 if possible
127245 Rudder	RSA	Two rudders supported
127250 Vessel Heading	HDG, HDM, HDT	See note (4)
127251 Rate of Turn	ROT	
127258 Magnetic Variation	—	See note (4)
127488 Engine Parameters, Rapid Update	RPM, XDR, DIN, PGN	See note (6)
127489 Engine Parameters, Dynamic	XDR, DIN	See note (6)
127493 Transmission Parameters, Dynamic	DIN, PGN	See note (6)
127501 Binary Status Report	DIN	See note (6)
127505 Fluid Level	DIN, PGN	See note (6)
127508 Battery Status	DIN, PGN	See note (6)
128259 Speed, Water referenced	VHW	Also may be used in RMC, VTG
128267 Water Depth	DBT, DBS, DPT	

Table 1 continued

NMEA 2000 PGN	NMEA 0183 Sentence	Comment
128275 Distance Log	VLW	
129025 Position, Rapid Update	GLL	Also use PGN 126992 or 129029
129026 COG & SOG, Rapid Update	VTG	Also used in RMC
129029 GNSS Position Data	GGA, GLL, RMC, ZDA	See also PGN 129033
129033 Local Time Offset	—	Time offset is used in ZDA
129044 Datum	DTM	
129283 Cross Track Error	XTE	
129284 Navigation Data	RMB, HSC	Use 129283, 129029 if possible
129285 Navigation — Route/WP information	—	Waypoint names from this message are used in RMB and APB sentences
129291 Set & Drift, Rapid Update	VDR	
129539 GNSS DOPs	GSA	PGN 129540 is also required
129540 GNSS Sats in View	GSV, GRS	PGN 129539, 129029 required
130066 Route and WP Service — Route/WP — List Attributes	RTE	Use waypoints from 130067
130067 Route and WP Service — Route — WP Name & Position	WPL	
130074 Route and WP Service — WP List — WP Name & Position	WPL	

Table 1 continued

NMEA 2000 PGN	NMEA 0183 Sentence	Comment
130306 Wind Data	MWD, MWV, VWR, VWT	See note (3). Also used in MDA.
130310 Environmental Parameters	XDR, MTW, MDA	See note (1), (5)
130311 Environmental Parameters	XDR, MTW, MDA	See notes (1), (2), (5)
130312 Temperature	XDR, MTW, MDA	See notes (1), (2), (5)
130313 Humidity	XDR, MDA	See notes (1), (2), (5)
130314 Actual Pressure	XDR, MDA	See notes (1), (2), (5)
130316 Temperature, Extended Range	XDR, MTW, MDA	See notes (1), (2), (5)
130578 Vessel Speed Components	VBW	
129038 AIS Class A Position Report	VDM, VDO	AIS VHF messages 1, 2 and 3
129039 AIS Class B Position Report	VDM, VDO	AIS VHF message 18
129040 AIS Class B Extended Position Report	VDM, VDO	AIS VHF message 19
129041 AIS Aids to Navigation (AtoN) Report	VDM, VDO	AIS VHF message 21
129793 AIS UTC and Date Report	VDM, VDO	AIS VHF messages 4 and 11
129794 AIS Class A Static and Voyage Related Data	VDM, VDO	AIS VHF message 5
129798 AIS SAR Aircraft Position Report	VDM, VDO	AIS VHF message 9
129802 AIS Safety Related Broadcast Message	VDO, VDM	AIS VHF Message 14
129809 AIS Class B «CS» Static Data Report, Part A	VDM, VDO	AIS VHF message 24

Table 1 continued

NMEA 2000 PGN	NMEA 0183 Sentence	Comment
129810 AIS Class B «CS» Static Data Report, Part B	VDM, VDO	AIS VHF message 24

Note (1): Air, dew point, inside (saloon), water and exhaust gas temperature, inside and outside humidity, barometric pressure are supported.

Note (2): Only messages with data instance 0 are converted.

Note (3): Device with factory settings perform conversion from true to apparent wind and vice versa. MWV sentence is sending twice (one for relative wind and one for true). See X.1 for details.

Note (4): Magnetic variation is used in RMC, HDT, HDG, VDR, VHW, VTG. Priority of variation PGNs: 127250, 127258, 65311.

Note (5): MDA is sent only when air, dew point or water temperature, or barometric pressure or outside humidity are available. Also contains wind speed and direction.

Note (6): DIN and PGN are wrap NMEA 2000 messages according SeaSmart (v1.6.0) and MiniPlex (v2.0) specifications. Engine revolutions, boost pressure, coolant temperature, hours, fuel rate, alternator voltage are also transmitted in XDR sentence.

Table 2. Conversions from NMEA 0183 to NMEA 2000

NMEA 0183 Sentence	NMEA 2000 PGN	Comment
APB	129283 Cross Track Error	Also used in PGN 129284
DIN	59904 ISO Request 127488 Engine Parameters, Rapid Update 127489 Engine Parameters, Dynamic 127493 Transmission Parameters, Dynamic 127502 Switch Bank Control 127505 Fluid Level 127508 Battery Status	According to SeaSmart.Net protocol specification v1.6.0
DPT	128267 Water Depth	
DTM	129044 Datum	
GGA	129029 GNSS Position Data	ZDA or RMC are required
GLL	129025 Position, Rapid Update	See note (7)
GSA	129539 GNSS DOPs	
GSV	129540 GNSS Sats in View	Use data from GRS and GSA
HDG	127250 Vessel Heading	
HDM, HDT	127250 Vessel Heading	Use variation and deviation from HDG
MDA	130311 Environmental Parameters 130314 Actual Pressure 130306 Wind Data	Relative air humidity, air and water temperature, atmospheric pressure, wind data
MOB	127233 Man Overboard Notification (MOB)	
MTW	130311 Environmental Parameters	
MWD	130306 Wind Data	

Table 2 continued

NMEA 0183 Sentence	NMEA 2000 PGN	Comment
MWV	130306 Wind Data	Theoretical wind sent as calculated using Heading/Speed through Water
RMB	129283 Cross Track Error 129284 Navigation Data 129285 Navigation — Route/WP information	Use data from APB; PGN 129284 sent twice with true and magnetic bearings
RMC	126992 System Time 127258 Magnetic Variation 129025 Position, Rapid Update 129026 COG & SOG, Rapid Update	See note (7)
RSA	127245 Rudder	
RTE	130066 Route and WP Service — Route/WP-List Attributes 130067 Route and WP Service — Route — WP Name & Position	Use data from WPL
ROT	127251 Rate of Turn	
VBW	130578 Vessel Speed Components	
VDR	129291 Set & Drift, Rapid Update	
VHW	128259 Speed, Water referenced	
VLW	128275 Distance Log	
VTG	129026 COG & SOG, Rapid Update	
VWR, VWT	130306 Wind Data	

Table 2 continued

NMEA 0183 Sentence	NMEA 2000 PGN	Comment
WPL	130074 Route and WP Service — WP List — WP Name & Position	Only waypoints not included to the route (the RTE should be received during 3 seconds after WPL).
XTE	129283 Cross Track Error	
ZDA	126992 System Time 129033 Local Time Offset	
VDO, VDM	129038 AIS Class A Position Report 129039 AIS Class B Position Report 129040 AIS Class B Extended Position Report 129041 AIS Aids to Navigation (AtoN) Report 129793 AIS UTC and Date Report 129794 AIS Class A Static and Voyage Related Data 129798 AIS SAR Aircraft Position Report 129802 AIS Safety Related Broadcast Message 129809 AIS Class B «CS» Static (AtoN) Report, Part A 129810 AIS Class B «CS» Static Data Report, Part B	AIS VHF messages 1, 2 and 3 AIS VHF message 18 AIS VHF message 19 AIS VHF message 21 AIS VHF messages 4 and 11 AIS VHF message 5 AIS VHF message 9 AIS VHF Message 14 AIS VHF message 24 AIS VHF message 24

Note (7): The Device provides 50 milliseconds intervals between outgoing NMEA 2000 messages that are generated by more than one NMEA 0183 sentence. For example, a message with PGN 129025 is generated only once if RMC and GLL are received within a 50 millisecond interval, and twice if the time between GLL and RMC is more than 50 milliseconds.

Note (8): Sentences with no significant data (or data marked as invalid) may not be translated to NMEA 2000 messages. NMEA 0183 sentences with invalid check sum are ignored.

APPENDIX D. Conversions Between SeaTalk and NMEA 0183

From SeaTalk Datagrams	NMEA 0183 Sentence	To SeaTalk Datagrams	Comment
Any	ALK	Any	Raw SeaTalk data (\$STALK sentence)
85 A2	APB	82 85 9E A1 A2	Heading/Track Controller Sentence «B» (Autopilot)
82 85 A1	BWC	82 85 9E A1	Bearing & Distance to Waypoint – Great Circle
—	BWR	82 85 9E A1	Bearing & Distance to Waypoint – Rhumb Line
00	DBT	00	Water Depth
00	DPT	00	Water Depth
50 51 58	GLL	50 51 58	Geographic Position – Latitude/ Longitude
89 (99)	HDG	89 99	Heading and Variation
89	HDM	89	Heading, Magnetic
89 (99)	HDT	89	Heading, True
23 27	MTW	23 27	Water Temperature
10 11	MWV	10 11	Wind Speed and Angle
85 A2	RMB	82 85 9E A1 A2	Recommended Minimum Navigation Information (Autopilot)
50 51 58	RMC	50 51 58 52 53 54 56 99	Recommended Minimum Specific GNSS Data
05	RPM	05	Engine Revolutions (three engines supported)
84 9C	RSA	9C	Rudder Sensor Angle

Table continued

20 26 84 89 9C (99)	VHW	20 26 89 9C 99	Water Speed (STW) and Heading
21 22 25	VLW	21 22 25	Trip and Total Distance
(52) 53	VTG	52 53 99	Course Over Ground & Ground Speed
9E A1	WPL	9E A1	Waypoint Location
85	XTE	85	Cross-Track Error (Autopilot)
54 56	ZDA	54 56	Time & Date

Note : (XX) means that the datagram does not cause sending of an NMEA sentence, but data from this datagram are used or required.

APPENDIX E. Format of Messages in RAW Mode

In RAW mode, network messages are converted to plain text format. We recommend that software developers support this format in applications because it is the easiest option. In the terminal window, NMEA 2000 messages look like a log in a chart plotter.

Messages sent from Device to PC have the following form:

```
hh:mm:ss.ddd D msgid b0 b1 b2 b3 b4 b5 b6 b7<CR><LF>
```

where:

- **hh:mm:sss.ddd** — time of message transmission or reception, ddd are milliseconds;
- **D** — direction of the message ('R' — from NMEA 2000 to application, 'T' — from application to NMEA 2000);
- **msgid** — 29-bit message identifier in hexadecimal format (contains NMEA 2000 PGN and other fields);
- **bo..b7** — message data bytes (from 1 to 8) in hexadecimal format;
- **<CR><LF>** — end of line symbols (carriage return and line feed, decimal 13 and 10).

Example:

```
17:33:21.107 R 19F51323 01 2F 30 70 00 2F 30 70
17:33:21.108 R 19F51323 02 00
17:33:21.141 R 09F80115 A0 7D E6 18 C0 05 FB D5
17:33:21.179 R 09FD0205 64 1E 01 C8 F1 FA FF FF
17:33:21.189 R 1DEFFF00 A0 0B E5 98 F1 08 02 02
17:33:21.190 R 1DEFFF00 A1 00 DF 83 00 00
17:33:21.219 R 15FD0734 FF 02 2B 75 A9 1A FF FF
```

Time of message is UTC time if the Device has received the time from the NMEA 2000 network, otherwise it is the time from Device start.

The format of messages sent from application to Device is the same, but without time and direction field. Outgoing messages must end with <CR><LF>. If the message from application is accepted, passes filters and is transmitted to NMEA 2000, it will be sent back to the application with “T” direction.

For example, the application sends the following sentence to the Device:

```
19F51323 01 02<CR><LF>
```

When this message is sent to the NMEA 2000 network, the Application receives an answer like:

```
17:33:21.108 T 19F51323 01 02<CR><LF>
```

The Application will get no answer if the message filtered or the message syntax is invalid.

The format of NMEA 2000 messages is available in Appendix B of NMEA 2000 Standard, which can be purchased on the site www.nmea.org.

